

Part No. FD9630
 ETD 29/16/10 Vertical Bobbin

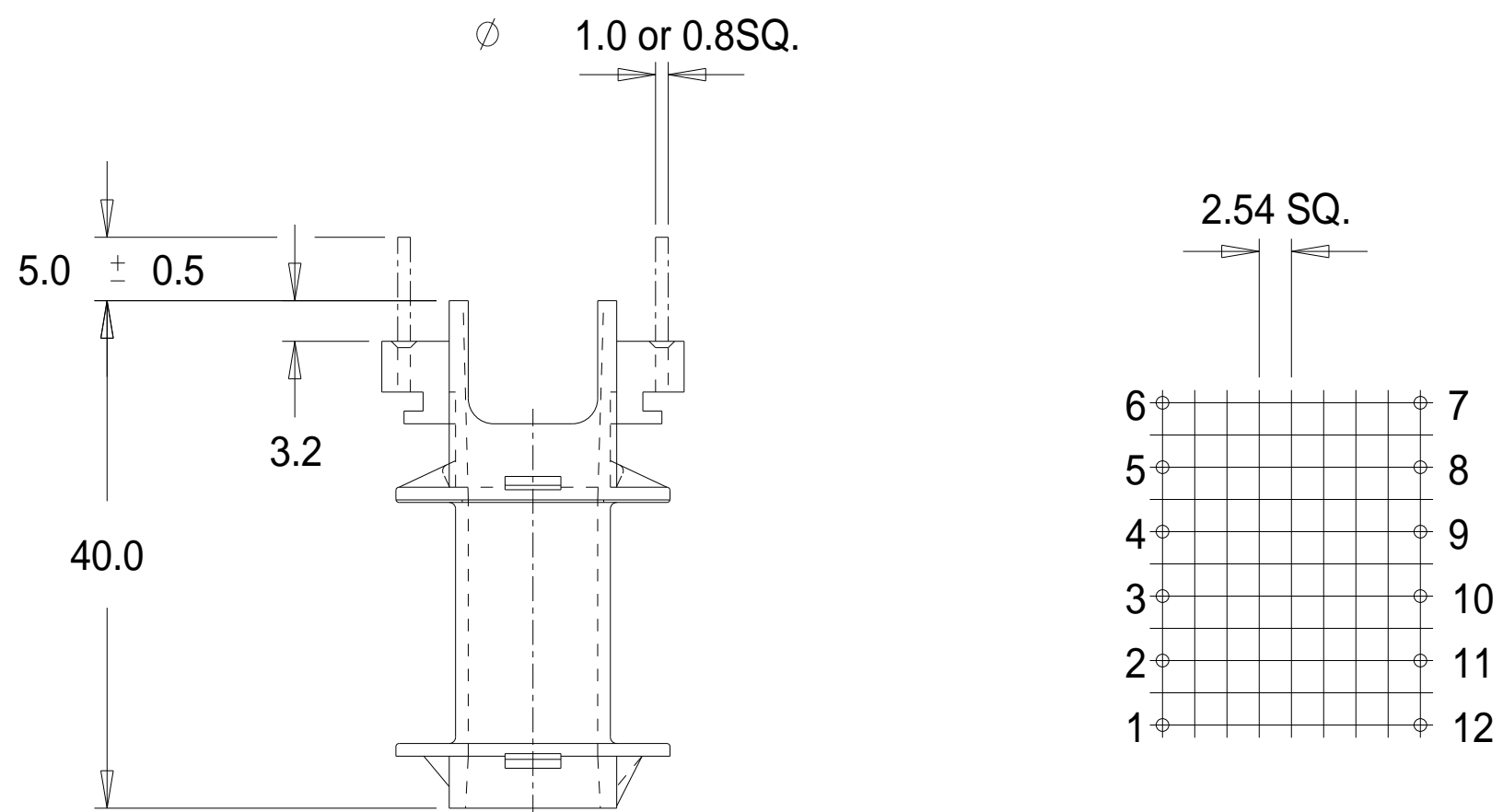

Dimensions in millimetres.

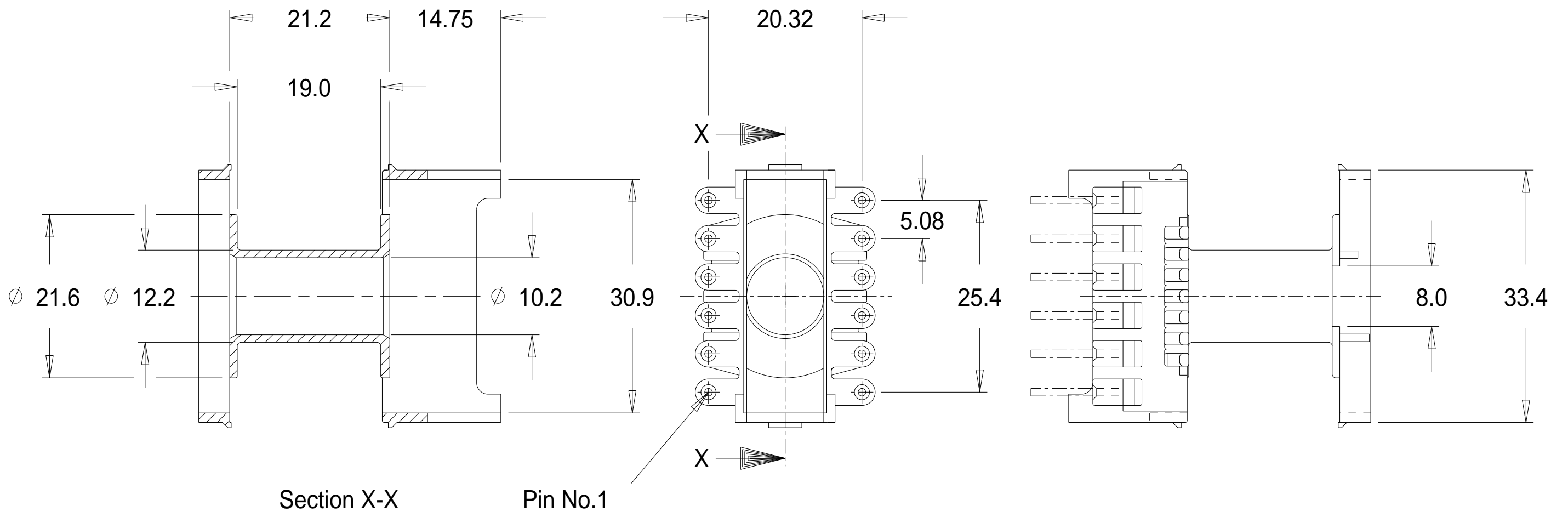