

Part No. FD9640

ETD 34/17/11 Vertical Bobbin

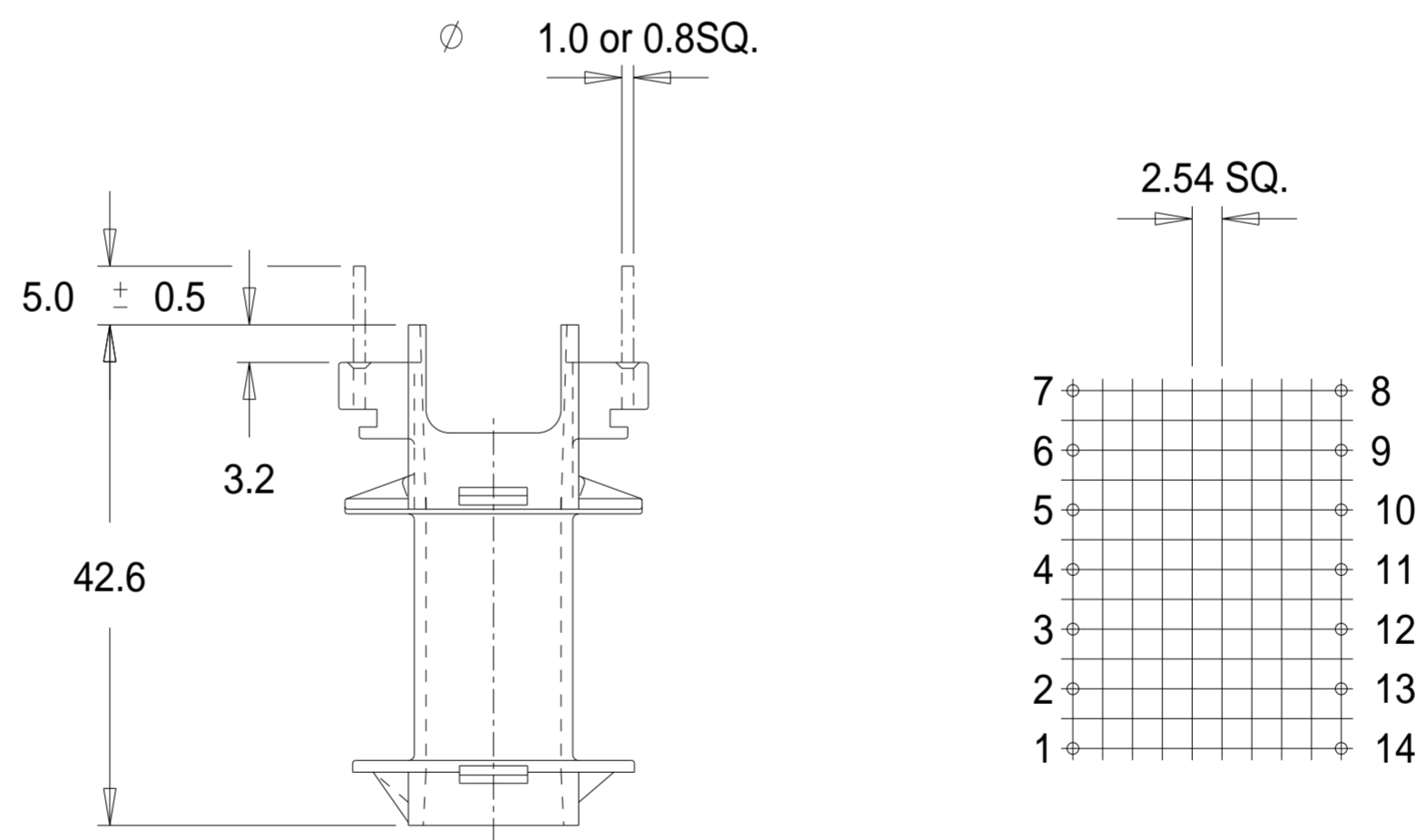

Dimensions in millimetres.

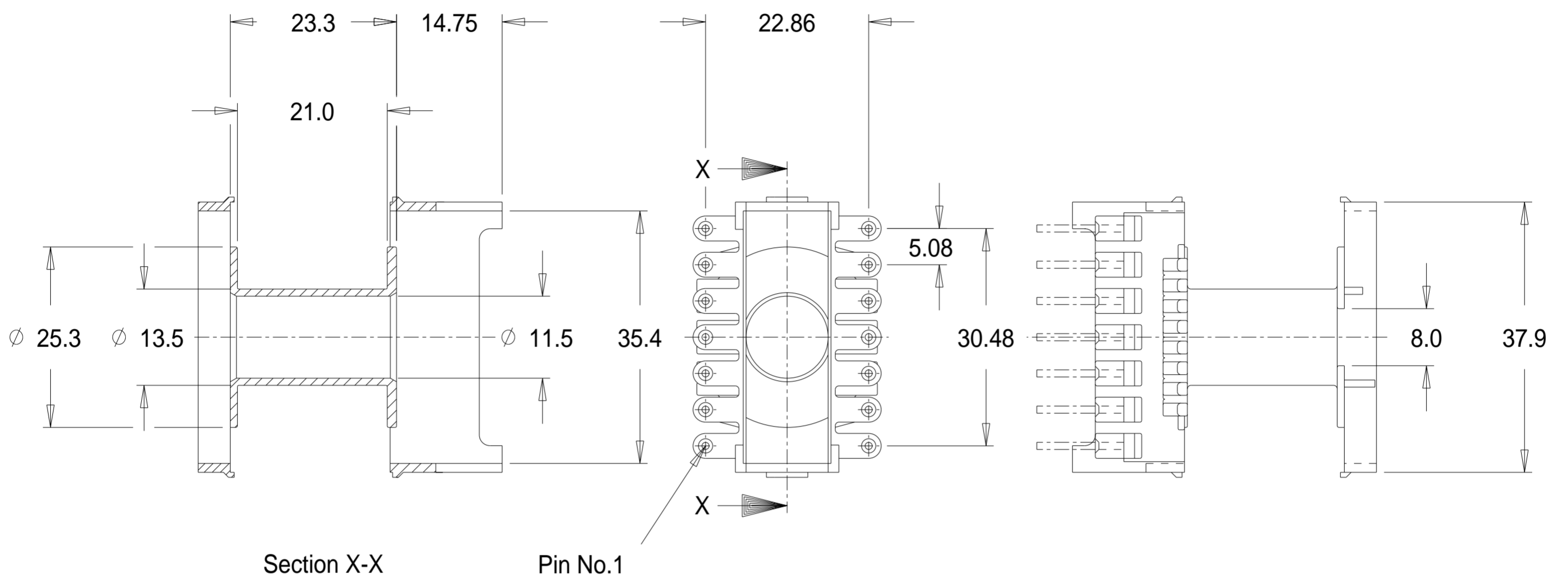