

Medium Power Film Capacitors

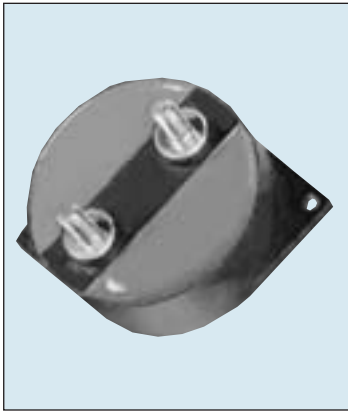

FFVE/FFVI Male and Female Connectors

DC FILTERING



GENERAL DESCRIPTION

The FFV capacitor is specifically designed for DC filtering, low reactive power.

The series uses a non-impregnated metallized polypropylene or polyester dielectric, which features a controlled self-healing process, specially treated to have a very high dielectric strength in operating conditions up to 105°C.

The FFV special design gives this series a very low level of stray inductance (18 nH to 40 nH).

Furthermore, the performance levels of the FFVE capacitor makes them a very interesting alternative to electrolytic technology, because they can withstand much higher levels of surge voltage, very high rms current ratings, and longer lifetimes.

PACKAGING

Self-extinguishing plastic case (V0 = in accordance with UL 94) filled thermosetting resin.

Self-extinguishing thermosetting resin (V0 = in accordance with UL 94; I3F1 = in accordance with NF F 16-101).

FFVE capacitors meet the Level 2 requirement of the fire behavior standard NF F 16-102.

DESIGN - Also available with threaded female connections - M5 x 7.5mm max Torque 2.5Nm

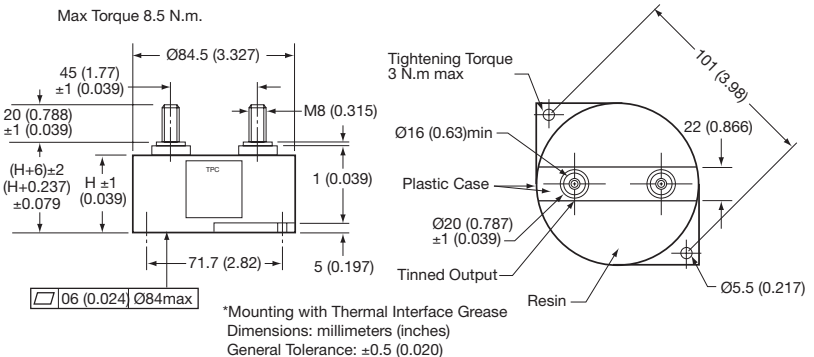

ELECTRICAL CHARACTERISTICS

The FFVE for low voltage DC filtering are polyester dielectric capacitors.

Working temperature	-40°C to +105°C (according to the power to be dissipated)
Capacitance range	12µF to 400µF
Capacitance tolerance	±10%
Rated DC voltage	300 to 1900 V
Test voltage between terminals @ 25°C	1.5 x V _n dc 10s (1.25 V _n dc – 10s for FFVI)
Insulation voltage between shorted terminals and earth	4 kVrms/60sec/50Hz

Rs(f) vs FREQUENCY

For frequency higher than 1 kHz use following curve

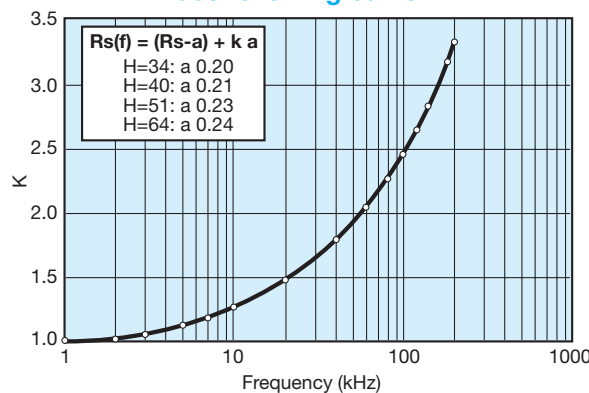

Medium Power Film Capacitors



FFVE/FFVI Male and Female Connectors

POLYESTER DIELECTRIC

Dimensions: millimeters (inches)

Capacitance (μF)	Height	Irms max. (A)	Ls max. (nH)	Rs (mΩ)	Rth (°C/W)	Part Number*
V_{ndc} 300 volts						
180	34 (1.339)	100	18	0.8	4.7	FFVE4H0187K--
195	34 (1.339)	100	18	0.8	4.4	FFVE4H1956K--
250	40 (1.575)	100	25	0.6	5.2	FFVE4H0257K--
350	51 (2.008)	100	32	0.8	7.2	FFVE4H0357K--
400	51 (2.008)	110	32	0.8	7.1	FFVE4H0407K--
V_{ndc} 400 volts						
100	34 (1.339)	80	18	0.7	4.7	FFVE4I0107K--
120	34 (1.339)	100	18	0.6	4.1	FFVE4I0127K--
150	40 (1.575)	100	25	0.7	5.0	FFVE4I0157K--
180	51 (2.008)	80	32	1.0	8.5	FFVE4I0187K--
220	51 (2.008)	100	32	0.9	7.2	FFVE4I0227K--

*Change "K--" to "KJE" for female connectors M5 x 7.5mm

LIFETIME EXPECTANCY FFVE POLYESTER

V_w: permanent working or operating DC voltage.

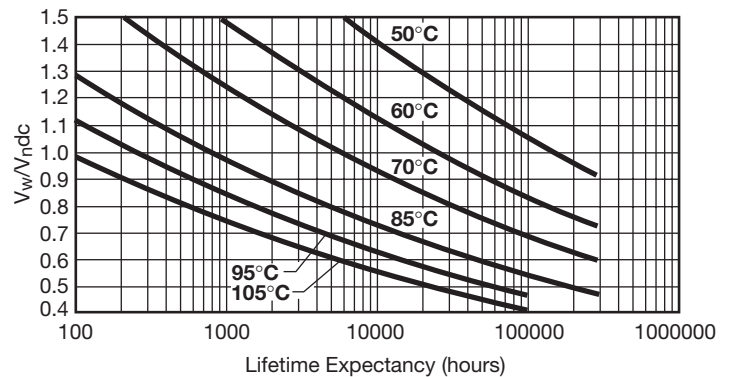

POLYPROPYLENE DIELECTRIC

Capacitance (μF)	Height	Irms max. (A)	Ls max. (nH)	Rs (mΩ)	Rth (°C/W)	Part Number*
V_{ndc} 600 volts						
25	34 (1.339)	90	18	0.7	4.3	FFVE6K0256K--
100	40 (1.575)	100	25	0.6	4.8	FFVE6K0107K--
150	51 (2.008)	110	32	0.9	6.9	FFVE6K0157K--
220	64 (2.520)	100	40	1.0	8.4	FFVE6K0227K--
V_{ndc} 800 volts						
66	40 (1.575)	100	25	0.7	4.7	FFVE6B0666K--
100	51 (2.008)	90	32	1.0	6.7	FFVE6B0107K--
140	64 (2.520)	100	40	1.3	8.4	FFVE6B0147K--
V_{ndc} 900 volts						
12	34 (1.339)	70	18	0.9	4.4	FFVE6C0126K--
38	34 (1.339)	100	18	1.6	3.9	FFVE6C0386K--
47	40 (1.575)	100	25	0.8	4.6	FFVE6C0476K--
70	51 (2.008)	100	32	1.2	6.7	FFVE6C0706K--
100	64 (2.520)	90	40	1.1	8.2	FFVE6C0107K--
V_{ndc} 1000 volts						
66	40 (1.575)	70	25	1.5	5.1	FFVE6L0666KJ7
100	51 (2.008)	64	32	2.0	7.3	FFVE6L0107KJ7
140	64 (2.520)	51	40	2.5	9.2	FFVE6L0147KJ7
V_{ndc} 1200 volts						
47	40 (1.575)	66	25	1.7	4.9	FFVE6U0476KJ7
70	51 (2.008)	59	32	2.4	7.2	FFVE6U0706KJ7
100	64 (2.520)	49	40	2.9	8.9	FFVE6U0107KJ7
V_{ndc} 1900 volts						
15	40 (1.575)	73	25	1.1	5.2	FFVE6N0156KJ7
24	51 (2.008)	73	32	1.3	6.5	FFVE6N0246KJ7
35	64 (2.520)	67	40	1.6	8.4	FFVE6N0356KJ7

*Change "K--" to "KJE" for female connectors M5 x 7.5mm

*Change "KJ7" to "K7X" for female connectors M5 x 7.5mm



Medium Power Film Capacitors



FFVE/FFVI Male and Female Connectors

LIFETIME EXPECTANCY FOR FFVE POLYPROPYLENE

K-- and KJE

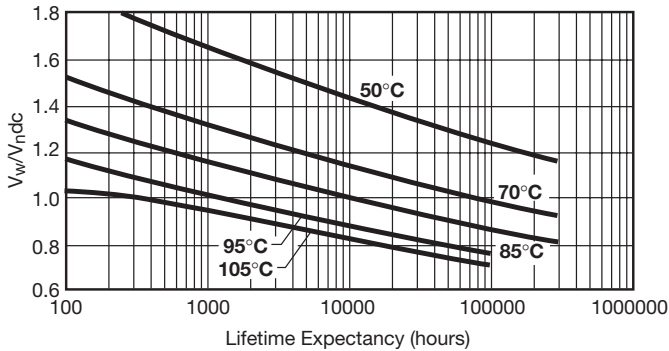

KJ7 and K7X

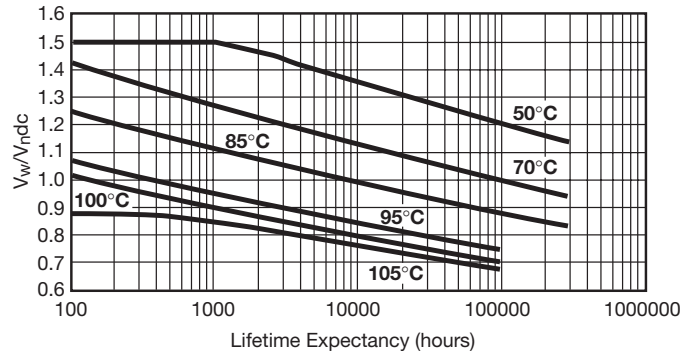

V_w : permanent working or operating DC-voltage.

V_w : permanent working or operating DC-voltage.

DC FILTERING

POLYPROPYLENE DIELECTRIC

Capacitance (μF)	Height	Irms max. (A)	Ls max. (nH)	Rs (mΩ)	Rth (°C/W)	Part Number*
V_{ndc} 500 volts						
125	40 (1.575)	90	25	0.6	5.0	FFVI6J1256K--
200	51 (2.008)	90	32	0.8	6.7	FFVI6J0207K--
275	64 (2.520)	90	40	0.9	8.7	FFVI6J2756K--
V_{ndc} 700 volts						
100	40 (1.575)	100	25	0.6	4.8	FFVI6A0107K--
150	51 (2.008)	100	32	0.9	6.9	FFVI6A0157K--
220	64 (2.520)	100	40	1.0	8.4	FFVI6A0227K--
V_{ndc} 900 volts						
66	40 (1.575)	100	25	0.7	4.7	FFVI6C0666K--
100	51 (2.008)	90	32	1.0	6.7	FFVI6C0107K--
140	64 (2.520)	100	40	1.3	8.4	FFVI6C0147K--
V_{ndc} 1100 volts						
47	40 (1.575)	100	25	0.8	4.6	FFVI6L0476K--
70	51 (2.008)	100	32	1.2	6.7	FFVI6L0706K--
100	64 (2.520)	90	40	1.1	8.2	FFVI6L0107K--

*Change "K--" to "KJE" for female connectors M5 x 7.5mm

LIFETIME EXPECTANCY FOR FFVI

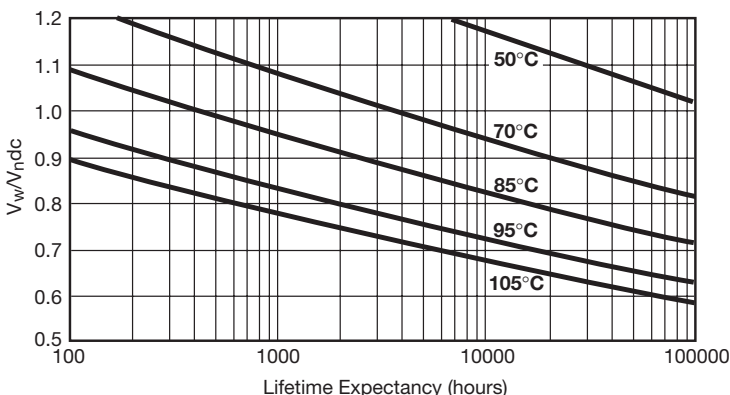

V_w : permanent working or operating DC-voltage.

HOT SPOT CALCULATION

$$\theta_{hot\ spot} = \theta_{case} + (P_d + P_t) \times R_{th}$$

with P_d (Dielectric losses) = $Q \times tg\delta_0$
 $\Rightarrow [\frac{1}{2} \times C_n \times (V_{peak\ to\ peak})^2 \times f] \times tg\delta_0$
 (see $tg\delta_0$ vs dielectric pages 2 and 3)

$$P_t \text{ (Thermal losses)} = R_s \times (I_{rms})^2$$

where C_n in Farad I_{rms} in Ampere f in Hertz
 V in Volt R_s in Ohm θ in °C
 R_{th} in °C/W R_{th} hot spot/bottom case